

UV LED TUBE - 370nm Series

Product Pictures.

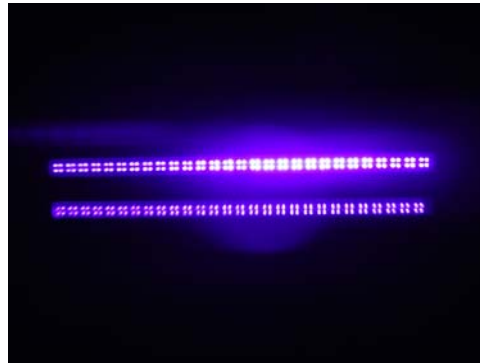

Product Applications.

UV light source for photocatalyst.
UV light source for curing.
Plan grow light for green house.
Aquarium Lighting.
Architectural Lighting.
Industrial emitters
Phosphors Stimulation

Product Features.

T8 Package
UV radiation.
Working without starter, ballast.
Directly replace traditional black light fluorescent tubes.
No flicker. Quick start. Water-resistant. Good color uniformity
Superior and unique design for perfect optical performance.
Up to 50% energy saving than conventional mercury lamps.
Lead-free, mercury-free, environment-friendly.

Typical Technical Characteristics.

General	Light Color	UV Light Source	Beam Angle	Material of Housing
For all types	Ultra Violet	VioLED 370-5R15	15 degree	UV Resistant Polycarbonate.

General	Operating Temperature	Storage Temperature	Dimensions (Dia. * Length)	Remark
For all types	-20 °C ~ +50 °C	-40 °C ~ +80 °C	1f: 30 * 330mm 2f: 30 * 580mm 4f: 30 * 1200mm	Custom wavelengths are available.

VioLED International Inc.

4F-2, No.427, Zhongshan N. Rd., Daya Dist., Taichung City 428, Taiwan.
TEL:886-4-25692507 FAX: 886-4-25691977 <http://www.violed.com.tw>

Specification & Device Selection Guide.

1 Foot T8 UV LED Tube (Cap Base = G13, Color of Housing = White)

P/N	λ_p	Input Voltage	Power Cons.	Output Power	LED Q'ty	Weight
370-1FUT-230V	365nm ~ 375nm	AC 230V	3.2W	168mw	56pcs	120g
370-1FUT-110V	365nm ~ 375nm	AC 110V	3.1W	168mw	56pcs	120g

2 Feet T8 UV LED Tube (Cap Base = G13, Color of Housing = White)

P/N	λ_p	Input Voltage	Power Cons.	Output Power	LED Q'ty	Weight
370-2FUT-230V	365nm ~ 375nm	AC 230V	9.4W	336mw	112pcs	180g
370-2FUT-110V	365nm ~ 375nm	AC 110V	7.0W	336mw	112pcs	180g

4 Feet T8 UV LED Tube (Cap Base = G13, Color of Housing = White)

P/N	λ_p	Input Voltage	Power Cons.	Output Power	LED Q'ty	Weight
370-4FUT-230V	365nm ~ 375nm	AC 230V	22.3W	672mw	224pcs	340g
370-4FUT-110V	365nm ~ 375nm	AC 110V	16.7W	672mw	224pcs	340g

Product Dimensions.

Unit: mm

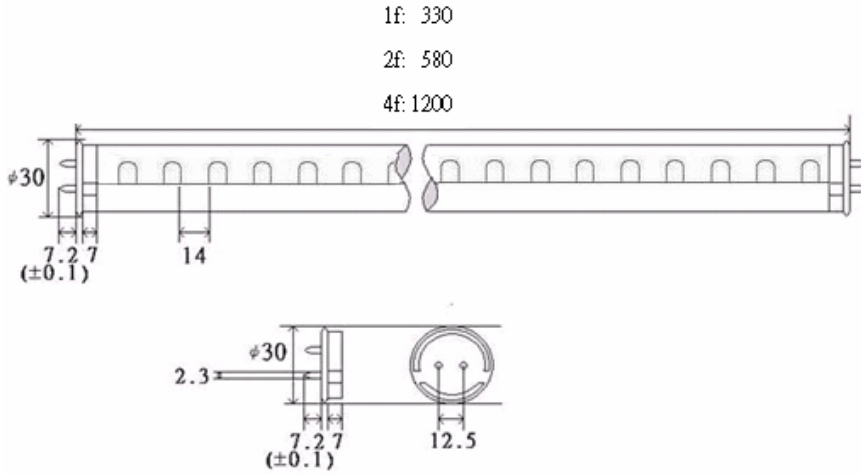

Packing Information.

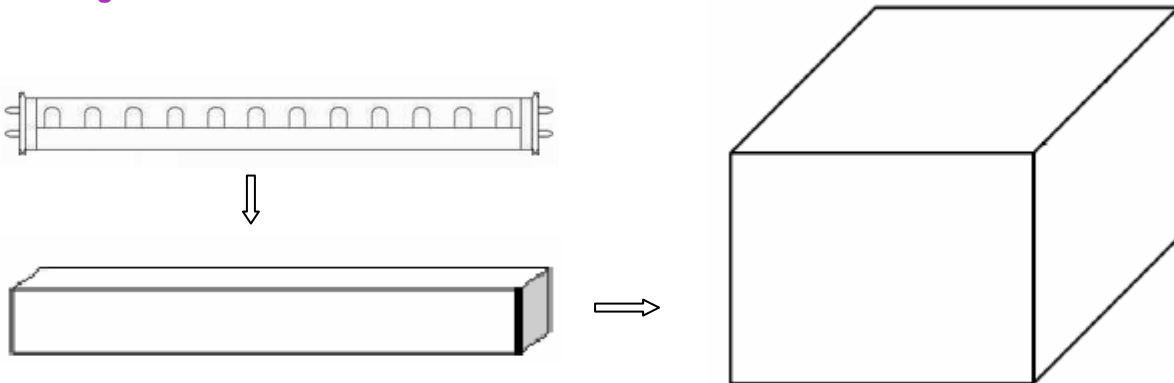

Pieces per Pack = 1 piece
Packs per Outer-Box = 40 (1 foot)
Packs per Outer-Box = 20 (2 feet)
Packs per Outer-Box = 10 (4 feet)

Warning.

UV LED light device, radiates intense UV light during operation.
Do not permit children or untrained personnel to operate this device.
Do not look directly into the UV light during operation of the device.
Exposure to UV light, even for a brief period, can damage your eyes.
During operation, the use of Ultra Violet protective goggles is recommended.

Installation.

Install in conventional light fixture:

- Step 1: Remove conventional black light fluorescent tube from light fixture.
- Step 2: Remove the starter (see below figures, no need to remove ballast)
- Step 3: Install uv led tube at original location of conventional black light fluorescent tube.
- Step 4: Rotate the tube slightly and make illumination angle suitable.
- Step 5: Turn on the power

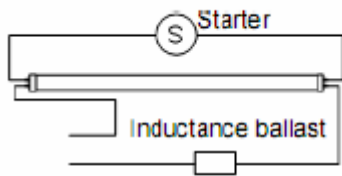

Before

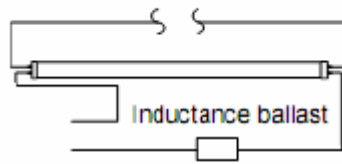

After



Original



Step 1 & 2



Step 3 & 4



Step 5